

Inserti filettati RIVSERT ciechi

Closed end RIVSERT rivet nuts

SFSC

34011

■ Acciaio

Steel



Fusto cilindrico cieco

Closed end cylindrical shank

Testa svasata

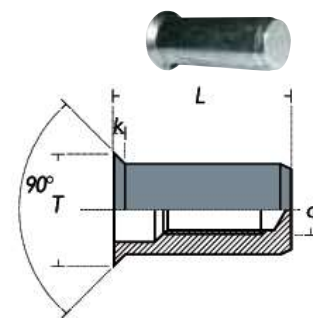
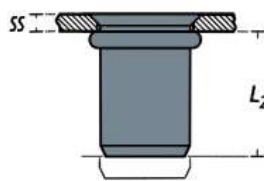
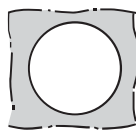
Countersunk head





d		T	k	SS	L	L ₂	Tipo	Codice		
mm	mm	mm	max	mm	mm	min ÷ max	Model	Item code	pz	pz
M4	6.0	9.0	1.5	1.3 ÷ 3.0	15.0	9.0 ÷ 10.0	SFSC0403006	0309800	1000N	8000
				3.0 ÷ 5.0	17.0	SFSC0405006	1071200	500S	8000	
M5	7.0	10.0	1.5	1.5 ÷ 4.0	20.0	13.0 ÷ 14.0	SFSC0504007	1712600	500N	6000
M6	9.0	12.0	1.5	1.5 ÷ 4.0	23.0	16.0 ÷ 17.0	SFSC0604009	0309900	250N	3000
				4.0 ÷ 6.5	26.0	SFSC0606509	0418800	250N	3000	
M8	11.0	14.0	1.5	1.5 ÷ 4.0	26.0	18.0 ÷ 19.0	SFSC0804011	0310000	250P	2000
				4.0 ÷ 6.5	29.0	SFSC0806511	0310200	250P	1500	
M10	13.0	15.0	1.5	1.5 ÷ 5.0	32.0	24.0 ÷ 25.0	SFSC1005013	0310300	100N	1000

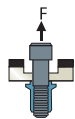

Applicazione
Application



d			Kg	N	Kgm	Nm
mm		mm				
M4		6.0	740	7300	0.4	4
M5		7.0	1160	11450	0.7	7
M6		9.0	1720	16900	1.5	15
M8		11.0	2460	24200	2.6	26
M10		13.0	3160	31000	4.5	45